

APROLI 280 BATT

OLEODINAMICO

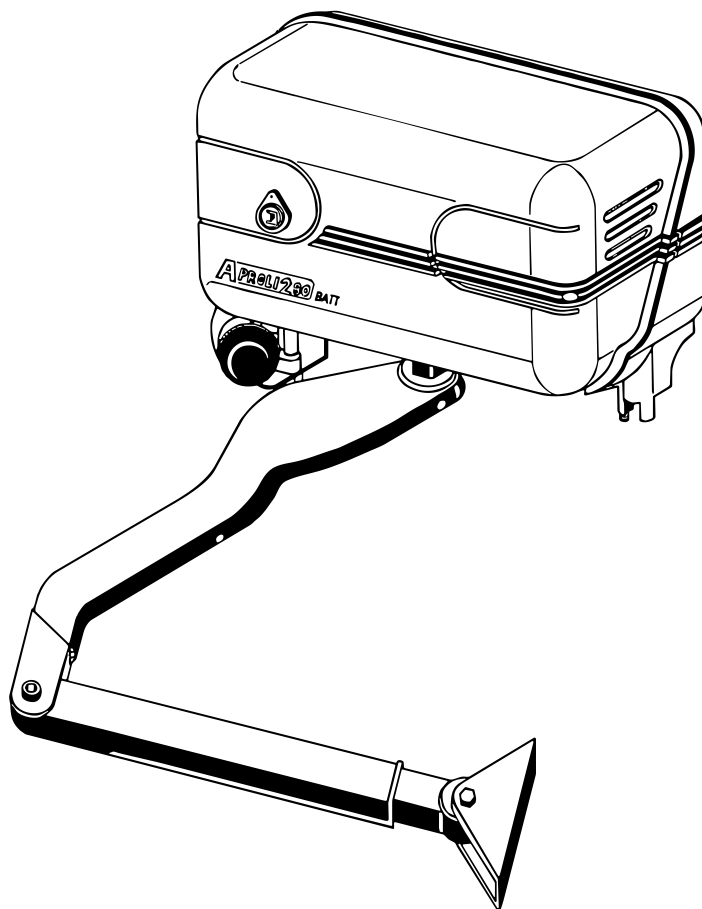









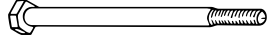







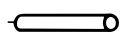



APRICANCELLO OLEODINAMICO
PER PILASTRI DI GRANDI DIMENSIONI













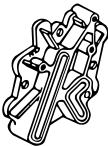





FADINI
l'apricancello
Made in Italy



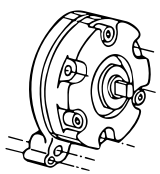

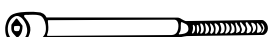

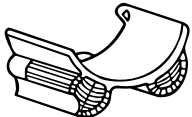
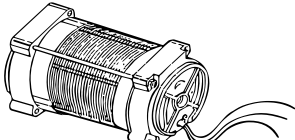
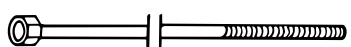
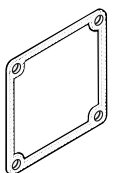
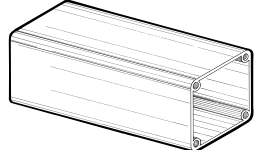
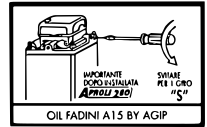

LISTINO PREZZI 2007

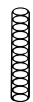

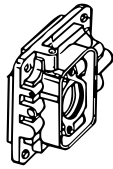

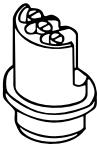

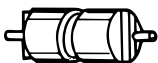

N. CODICE	FIGURA	N. ART.	DENOMINAZIONE	QUANTITÀ	LISTINO PREZZI €
28001		1	Vite M8x120 T.E.	4	
28002		2	Vite M8x35 T.E. (NON SI USA PIÙ, SOSTITUITO CON 110)	2	
28003		3	Vite M8x45 T.E. (NON SI USA PIÙ, SOSTITUITO CON 110)	2	
28004		4	Vite di regolazione flusso verticale	1	
28005		5	Guarnizione OR 2018	9	
28006		6	Frontale di attacco gruppo motore elettrico/martinetto idraulico (NON SI USA PIÙ, SOSTITUITO CON 106)	1	
28007		7	Tubo di mandata Ø 8x19 (NON SI USA PIÙ)	1	
28008		8	Tubetto in gomma	1	
28009		9	Spina elastica Ø 4x28	1	
28010		10	Guarnizione OR 176	2	

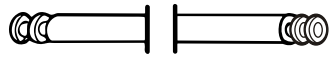

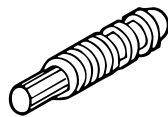
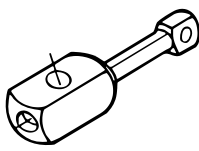

28011		11	Dado M8 E13 (NON SI USA PIÙ)	2	
28012		12	Corpo valvola bidirezionale (NON SI USA PIÙ, SOSTITUITO CON 106)	1	
28013		13	Guarnizione OR 2043	3	
28014		14	Registro di massima pressione	2	
28015		15	Sfera Ø 6,35	4	
28016		16	Molla a compressione 1,2x7,2x29	2	
28017		17	Pastiglia in nylon valvola massima	2	
28018		18	Guarnizione OR 119	2	
28019		19	Tappo laterale blocco bidirezionale	2	
28020		20	Molla conica 0,35x7,2x12	2	
28021		21	Sfera Ø 10,319 (NON SI USA PIÙ, SOSTITUITO CON 15)	2	

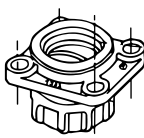



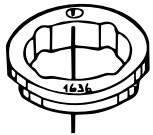
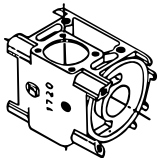

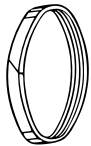

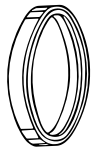
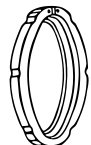
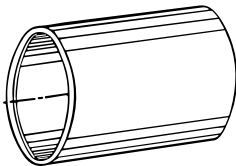
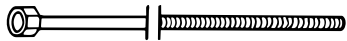
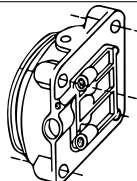
28022		22	Sede valvola di ritenuta	2	
28023		23	Guarnizione OR 3043	2	
28024		24	Guarnizione OR 2118 (NON SI USA PIÙ)	2	
28025		25	Piastra distributrice olio (NON SI USA PIÙ)	1	
28026		26	Guarnizione OR 2093 (NON SI USA PIÙ)	1	
28027		27	Guarnizione OR 2137 (NON SI USA PIÙ)	1	
28028		28	Vite M5x16 T.E.I.	8	
28029		29	Molla a compressione 0,3x4,6x12 (NON SI USA PIÙ, SOSTITUITO CON 111)	2	
28030		30	Distanziale sagomato (NON SI USA PIÙ)	1	
28031		31	Guarnizione OR 2025	2	
28032		32	Guarnizione OR 108	2	

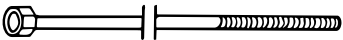

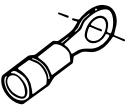

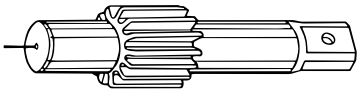

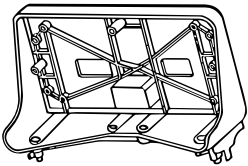
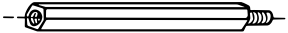
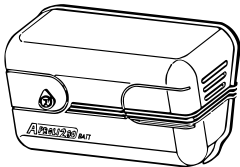
28033		33	Pompa idraulica a lobi	1	
28034		34	Vite M5x35 T.E.I.	3	
28035		35	Vite M5x55 T.E.I. (NON SI USA PIÙ, SOSTITUITO CON 34)	1	
28036		36	Parastrappi in ottone	1	
28037		37	Filtro aspirazione olio	1	
28038		38	Motore elettrico 0,25 Cv	1	
28039		39	Tirante M5x158 motore/pompa (NON SI USA PIÙ, SOSTITUITO CON 113)	1	
28040		40	Guarnizione di tenuta	2	
28041		41	Serbatoio olio	1	
28042		42	Adesivo d'istruzione per lo sfiato	1	
28043		43	Tirante serbatoio M5x235 (NON SI USA PIÙ)	4	





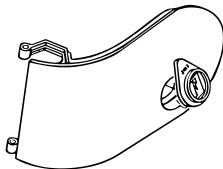
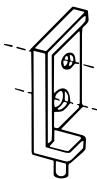

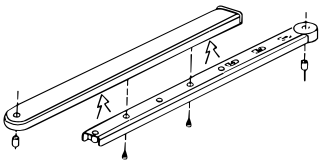
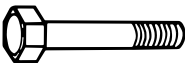
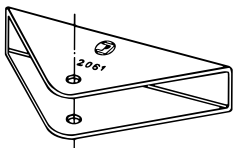
28044		44	Molla di sfiato 0,4x2,8x18 (NON SI USA PIÙ)	1	
28045		45	Sfera Ø 3,9 (NON SI USA PIÙ)	2	
28046		46	Vite di sfiato	1	
28047		47	Fondello serbatoio	1	
28048		48	Dado cieco M5 (NON SI USA PIÙ, SOSTITUITO CON 110)	4	
28049		49	Guarnizione OR 20x3	1	
28050		50	Pres a elettrica a tappo	1	
28051		51	Seeger J28	1	
28052		52	Coperchio presa elettrica (NON SI USA PIÙ, SOSTITUITO CON 114)	1	
28053		53	Vite M5x10 T.C. (NON SI USA PIÙ, SOSTITUITO CON 116)	1	
28054		54	Cilindretto bidirezionale	1	



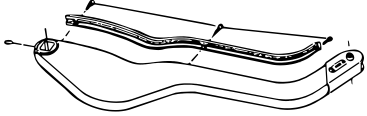
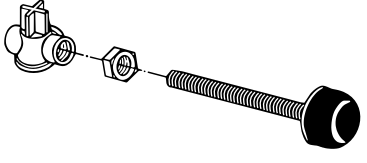

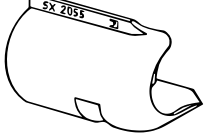
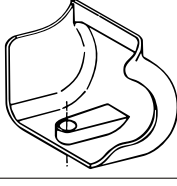

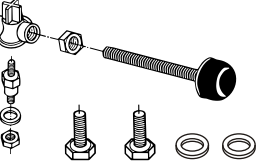
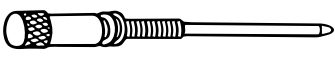

28055		55	Tubo di mandata Ø 8x278	1	
28056		56	Pastiglia a tappo	1	
28057		57	Registro di sblocco	1	
28058		58	Leva di registro sblocco	1	
28059		59	Grano M6x8	1	
28060		60	Ghiera di fermo registro	1	
28061		61	Guarnizione OR 2031	1	
28062		62	Grano M5x5	3	
28063		63	Supporto albero	2	
28064		64	Guarnizione OR 4100	2	
28065		65	Guarnizione OR 3125	2	



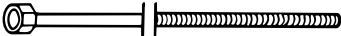
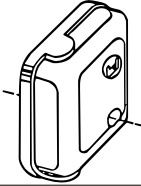



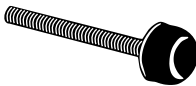

28066		66	Distanziale	2	
28067		67	Corpo a croce	1	
28068		68	Guarnizione di tenuta (NON SI USA PIÙ)	2	
28069		69	Asta dentata	1	
28070		70	Pattino di sfregamento	2	
28071		71	Stantuffo con inserto in acciaio	2	
28072		72	Guarnizione 70 80 7	2	
28073		73	Ghiera di fermo guarnizione	2	
28074		74	Camicia	2	
28075		75	Tirante M5x142 motore/pompa	1	
28076		76	Testata martinetto	1	

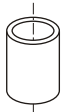
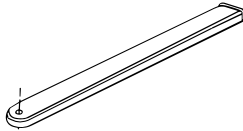
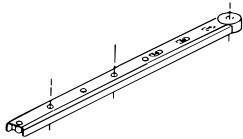

28077		77	Tirante M8x298	2	
28078		78	Targa adesiva dati tecnici	1	
28079		79	Sfera Ø 3,175 (NON SI USA PIÙ)	1	
28080		80	Morsetto massa a terra	1	
28081		81	Vite M5x6 T.C.	1	
28082		82	Albero dentato	1	
28083		83	Rondella elastica da 5	8	
28084		84	Staffa di supporto	1	
28085		85	Prigioniero di fissaggio	2	
28086		86	Cofano di protezione	1	
28087		87	Vite M5x10 T.E.I. inox	2	

28088		88	Cilindro serratura con dado M6	1	
28089		89	Chiavi serratura	2	
28090		90	Levetta di fermo	1	
28091		91	Portiera cofano di protezione e copriserratura	1	
28092		92	Supporto inferiore cerniera	1	
28093		93	Supporto superiore cerniera	1	
28094		94	Vite M4,2x9,5 T.C. autofilettante	2	
28095		95	Asta di prolunga e copriasta completa di viti e boccole	1	
28096		96	Vite M8x50 T.E.	2	
28097		97	Staffa di attacco	1	
28098		98	Dado M8 autobloccante	2	

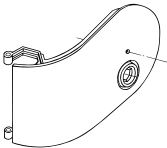
28099		99	Asta a gomito di comando e copri completa di viti	1	
280100		100	Registro a cappello con dado e gambo a snodo	1	
280101		101	Prigioniero di fissaggio con dado e rondella	1	
280102		102	Copri registro sinistro	1	
280103		103	Copri registro destro	1	
280104		104	Vite M8x30 T.E. di fissaggio gruppo motore a basamento	4	
280105		105	Rondella da 8 inox	4	
280106		106	Corpo valvola bidirezionale/ attacco martinetto	1	
		107			
280108		108	Battuta d'arresto con registro, due viti M8x30 e due rondelle	1	
280109		109	Vite di regolazione flusso orizzontale	1	

280110		110	Vite M6x20 T.E.I.	8	
280111		111	Molla a compressione 0,5x6,5x6	2	
280112		112	Sfera Ø 7,5	2	
280113		113	Tirante M5x155 motore/pompa	1	
280114		114	Coperchio presa elettrica	1	
280115		115	Guarnizione OR 2015	8	
280116		116	Vite M5x20 T.E.I.	1	
280117		117	Gambo a snodo di fermo	1	
280118		118	Dado M14 E22	1	
280119		119	Prigioniero di fissaggio	1	
280120		120	Registro a cappello	1	

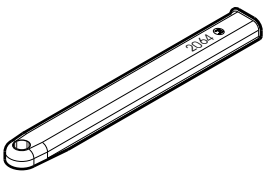
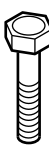
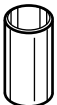
280121		121	Grano di fermo M8x10	1	
280122		122	Asta a gomito di comando	1	
280123		123	Copri fessura	1	
280124		124	Vite M5x16 T.E.I.	3	
280125		125	Boccola in nylon Ø 14,5x22	2	
280126		126	Copri asta di prolunga	1	
280127		127	Terminale asta di prolunga	1	
280128		128	Copri serratura	1	
280129		129	Portiera cofano di protezione	1	
280130		130	Silicone adesivo uso guarnizione per camicia = RTV 1473 Q =	1	
		131			

280132		132	Copri asta di prolunga con foro maggiorato	1	
280133		133	Vite M12x50 T.E.	1	
280134		134	Boccola in plastica ø16,3x22 maggiorata	1	
280135		135	Dado autobloccante M12	1	
280136		136	Silicone adesivo uso guarnizione per camicia = RTV 1473 Q =	1	
		137			
		138			
		139			
		140			
		141			
		142			

LISTINO PREZZI 2007

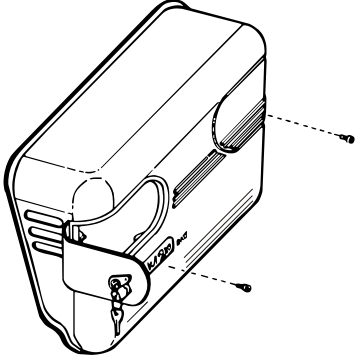
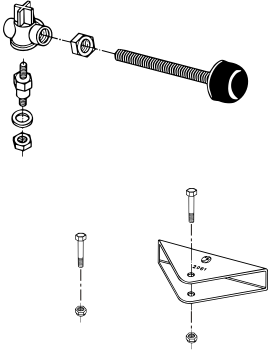
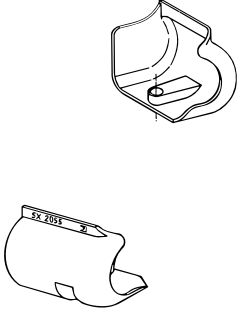
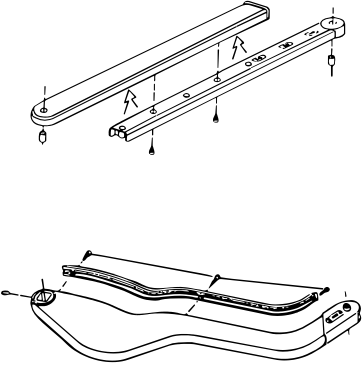
N. CODICE	FIGURA	DENOMINAZIONE	PREZZO COMP.VO
280861		Cofano di protezione completo di: n° 86-87-88-89-90-91-92-93-94	
2801001		Confezione accessori completa di: n° 96-97-98-100-101	
2801021		Confezione con copri registro completa di: n° 102-103	
280951		Asta di comando completa di: n° 95-99	

LISTINO PREZZI 2007

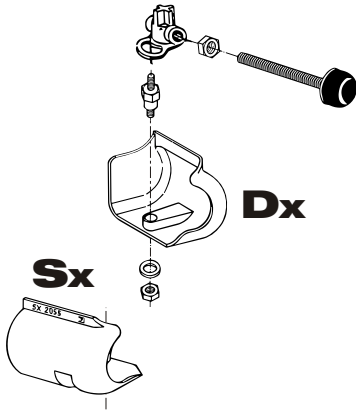
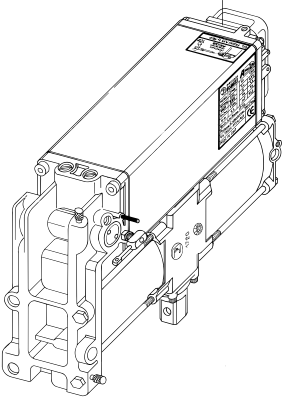
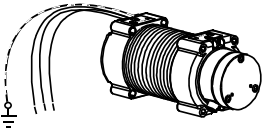
N. CODICE	FIGURA	DENOMINAZIONE	PREZZO COMP.VO
2801002		Confezione battuta di arresto completa di: n° 100-101-102-103	
280200		Gruppo motore elettrico/martinetto idraulico	
280154		Motore/pompa in alluminio a lobi da 3 - Pacco 60 -	

LISTINO PREZZI 2007

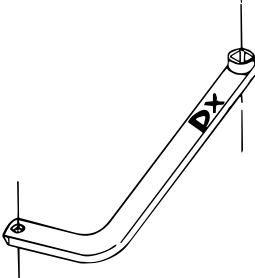
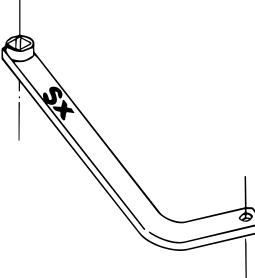
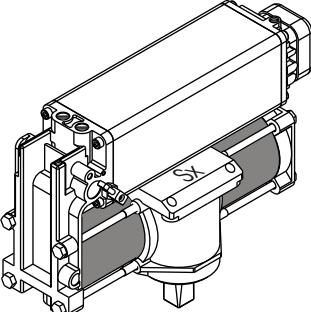
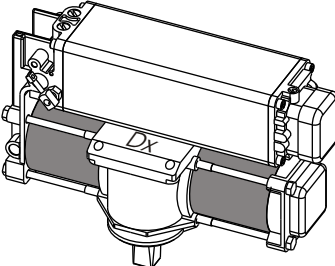
N. CODICE	FIGURA	DENOMINAZIONE	PREZZO COMP.VO
280952		Braccio di leva <u>Aproli 280/700 Robusto</u> in acciaio. DESTRO	
280953		Braccio di leva <u>Aproli 280/700 Robusto</u> in acciaio. SINISTRO	
280791	 <p style="text-align: center;">Sinistro</p>	Gruppo motore elettrico/martinetto/serbatoio <u>Aproli 280/700 Robusto</u> Sinistro Sx	
280792	 <p style="text-align: center;">Destro</p>	Gruppo motore elettrico/martinetto/serbatoio <u>Aproli 280/700 Robusto</u> Destro Dx	